

Isolated converter for PTC/Pot configurable by Dip-Switch or PC

DAT 4531 C

FEATURES

- Configurable input for PTC and Potentiometer
- Configurable input for NTC Coster 1K and Coster 10K
- Configurable by dip-switch or PC
- High accuracy
- On-field reconfigurable
- Galvanic isolation among the ways
- UL / CE / UKCA mark
- Suitable for DIN rail mounting in compliance with EN-50022 and EN-50035



GENERAL DESCRIPTION

The isolated converter DAT 4531 C is able to measure and linearise the PTC type KTY81 and KTY84, NTC sensors **exclusively** type Coster 1K and 10K and potentiometers.

In function of programming, the measured values are converted in a current or voltage signal. The device guarantees high accuracy and performances stability both versus time and temperature.

The programming is made by the dip-switch located in the window on the side of the enclosure. By means of dip-switches it is possible to select the input type and range and the output type without recalibrate the device.

Moreover, by Personal Computer the user can program all of the device's parameters for his own necessity.

Moreover it is available the option of alarm for signal interruption (burn-out) that allows to set the output value as high or low out of scale .

The 1500 Vac galvanic isolation on all ways (input, output and power supply) eliminates the effects of all ground loops eventually existing and allows the use of the converter in heavy environmental conditions found in industrial applications.

The DAT 4531 C is in compliance with the Directive UL 61010-1 for US market and with the Directive CSA C22.2 No 61010-1 for the Canadian market.

It is housed in a plastic enclosure of 12.5 mm thickness suitable for DIN rail mounting in compliance with EN-50022 and EN-50035 standards.

USER INSTRUCTIONS

The connections must be made as shown in the section "Connections".

It is possible to configure the converter on field by dip-switch or Personal Computer as shown in the section " Programming" . The configuration by dip-switches can be made also if the device is powered (note: after the configuration the device takes some seconds to provide the right output measure) .

TECHNICAL SPECIFICATIONS (Typical at 25 °C and in nominal conditions)

INPUT				OUTPUT				GENERAL SPECIFICATIONS	
Input type	Min	Max	Span min	Output type	Min	Max	Span min		
PTC(*)				Current	0 mA	20 mA	4 mA	Power supply voltage	18 .. 30 Vdc
KTY81-210	-55°C	150°C	50°C	Voltage	0 V	10 V	1 V	Reverse polarity protection	60 Vdc max
KTY81-220	-55°C	150°C	50°C					Current consumption	
KTY84-130	-40°C	300°C	50°C					Current output	35 mA max.
KTY84-150	-40°C	300°C	50°C					Voltage output	20 mA max.
NTC(*)				Output resolution				ISOLATION	
Coster 10K	-10°C	100°C	50°C	Current		± 7 uA		Among all the ways	1500 Vac,
Coster 1K	-30°C	40°C	25°C	Voltage		± 4 mV			50 Hz, 1 min
Pot. (Rnom.< 50KΩ)	0 %	100 %	10 %	Burn-out values				ENVIRONMENTAL CONDITIONS	
				Max. output value		22 mA or 10.6 V		Operative Temperature	-20°C .. +60°C
				Min. output value		0 mA or -0.6 V		UL Operative Temperature	-10°C .. +60°C
				Output load Resistance - Rload				Storage Temperature	-40°C .. +85°C
				Current output		< 500 Ω		Humidity (not condensed)	0 .. 90 %
				Voltage output		> 10 KΩ		Maximum Altitude	2000 m
				Short circuit current		26 mA max.		Installation	Indoor
				Response time (10÷ 90%)		about 500 ms		Category of installation	II
Accuracy (1)								Pollution Degree	2
PTC, NTC	the higher of ±0.1% and ±0.2°C							MECHANICAL SPECIFICATIONS	
Potentiometer	± 0.05 % f.s.							Material	Self-extinguish plastic
Linearity (1)								IP Code	IP20
PTC,NTC	± 0.1 % f.s.							Wiring	wires with diameter
Sensor excitation current									0.8÷2.1 mm ² /AWG 14-18
PTC,NTC	500 uA							Tightening Torque	0.8 N m
Line resistance influence (1)								Mounting	in compliance with DIN
RTD 3 wires	0.05%/Ω (50 Ω max balanced)								rail standard EN-50022
Thermal drift (1)									and EN-50035
Full scale	± 0.01% / °C							Weight	about 90 g.
								CERTIFICATIONS	
								EMC (for the Industrial Environments)	
								Immunity	EN 61000-6-2
								Emission	EN 61000-6-4
								UKCA (ref S.I. 2016 N°1091)	
								Immunity	BS EN 61000-6-2
								Emission	BS EN 61000-6-4
								UL	
								US Standard	UL 61010-1
								Canadian Standard	CSA C22.2 No 61010-1
								CCN	NRAQ/NRAQ7
								Typology	Open Type device
								Classification	Industrial Control
									Equipment
								File Number	E352854

(*) if the NTC or PTC sensor used does not match to the types indicated, verify that the characteristic ohm / °C of such sensor corresponds to the characteristic ohm / °C of the sensors listed above. If it does not, the device won't be suitable to measure the specific sensor.

(1)referred to the input Span (difference between max. and min.)

CONFIGURATION BY DIP-SWITCHES

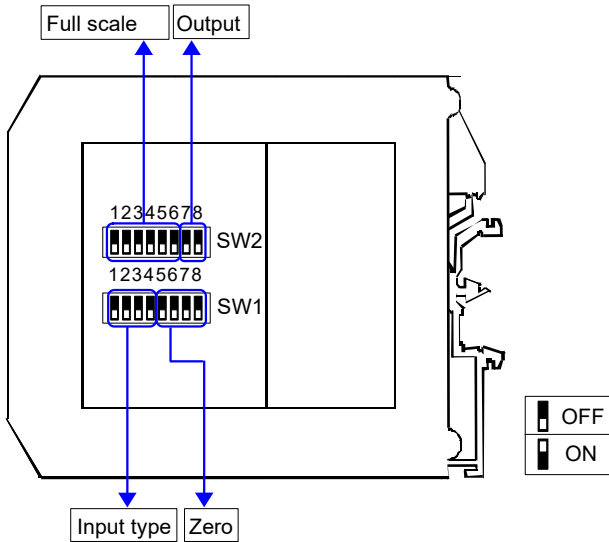

PROGRAMMING

- 1) Open the suitable door on the side of the device.
- 2) Set the input type by the dip-switch SW1 [1..4] (see TAB.1)
- 3) Set the minimum input scale value (Zero) by the dip-switch SW1 [5..8] (see TAB.3)
- 4) Set the maximum input value (Full scale) by the dip-switch SW2 [1..6] (see TAB.3)
- 5) Set the output type by the dip-switch SW2 [7..8] (see TAB.2)

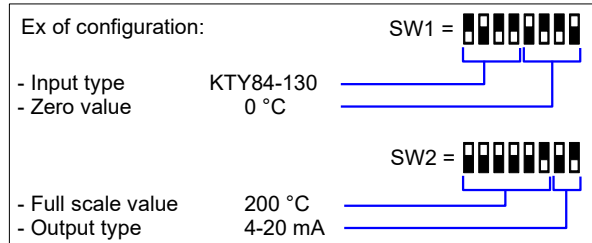

NOTE:

- It is also possible to set the dip-switches using the wizard of the configuration software following the procedure described in the section "Configuration by PC" until the step 6 and clicking on "Switch".

DIP-SWITCH CONFIGURATION TABLES

TAB.1
Input type settings

SW1	1	2	3	4	Setting
<input type="checkbox"/>	<input type="checkbox"/>	<input type="checkbox"/>	<input type="checkbox"/>	<input type="checkbox"/>	EPROM *
<input type="checkbox"/>	<input type="checkbox"/>	<input type="checkbox"/>	<input type="checkbox"/>	<input type="checkbox"/>	Pot
<input type="checkbox"/>	<input type="checkbox"/>	<input type="checkbox"/>	<input type="checkbox"/>	<input type="checkbox"/>	KTY81-210 KTY81-220
<input type="checkbox"/>	<input type="checkbox"/>	<input type="checkbox"/>	<input type="checkbox"/>	<input type="checkbox"/>	KTY84-130 KTY84-150
<input type="checkbox"/>	<input type="checkbox"/>	<input type="checkbox"/>	<input type="checkbox"/>	<input type="checkbox"/>	Coster 10K
<input type="checkbox"/>	<input type="checkbox"/>	<input type="checkbox"/>	<input type="checkbox"/>	<input type="checkbox"/>	Coster 1K

TAB.2
Output setting

SW2	7	8	Setting
<input type="checkbox"/>	<input type="checkbox"/>	<input type="checkbox"/>	0-20 mA
<input type="checkbox"/>	<input type="checkbox"/>	<input type="checkbox"/>	4-20 mA
<input type="checkbox"/>	<input type="checkbox"/>	<input type="checkbox"/>	0-10 V
<input type="checkbox"/>	<input type="checkbox"/>	<input type="checkbox"/>	0-5 V

NOTES:

* To configure the range for the input type selected (TAB.1) refer to the section of the TAB.3 on next page relative to it (ex: for Potentiometer use the table TAB.3b).

* If the dip-switches SW1 [1..4] are all set in the position 0 ("EPROM"), the device will follow the configuration programmed by PC (input type and range, output type and range and options).

* If the dip-switches SW1 [5..8] are all set in the position 0 ("Default"), the device will follow the input scale programmed by PC for the input type selected by the dip-switches SW1 [1..4]

* Eventual wrong dip-switches settings will be signalled by the blinking of the led "PWR".

CONFIGURATION BY PC

Notice: before to execute the next operations, check that the drivers of the cable CVPROG in use have been previously installed in the Personal Computer.

By software DATAPRO it is possible to:

- set the default programming of the device;
- program the options not available with the dip-switch; (burn-out level, CJC offset, trip alarm settings, delay on output, etc...);
- read, in real time, the input and output measures;
- follow the dip-switches configuration wizard.

To configure the device follow the next steps:

- 1) Open the protection plastic label on the front of the device.
- 2) Connect the two plugs of cable CVPROG to the Personal Computer (USB plug) and to the device (uUSB plug).
- 3) Run the software
- 4) Select the COM port in use and click on "Open COM".
- 5) Select the device and connect to it.
- 6) Set the programming data.
- 7) Click "Write" to send the programming data to the device.

For information about the software refer to its user guide.

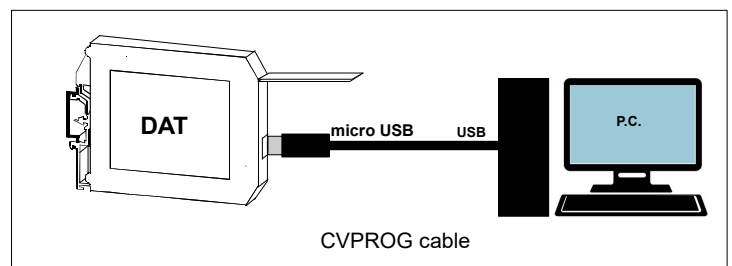

TAB.3a – Settings for PTC, NTC

Zero		Full scale									
SW1 5 6 7 8	°C	SW2 1 2 3 4 5 6	°C	SW2 1 2 3 4 5 6	°C	SW2 1 2 3 4 5 6	°C	SW2 1 2 3 4 5 6	°C	SW2 1 2 3 4 5 6	°C
Default		Default			75		210				370
	-200		0		80		220				380
	-150		5		85		230				390
	-100		10		90		240				400
	-50		15		95		250				425
	-40		20		100		260				450
	-30		25		110		270				475
	-20		30		120		280				500
	-10		35		130		290				525
	0		40		140		300				550
	5		45		150		310				600
	10		50		160		320				650
	20		55		170		330				700
	30		60		180		340				750
	50		65		190		350				800
	100		70		200		360				850

TAB.3b –Settings for Potentiometer

Zero		Full scale									
SW1 5 6 7 8	%	SW2 1 2 3 4 5 6	%	SW2 1 2 3 4 5 6	%	SW2 1 2 3 4 5 6	%	SW2 1 2 3 4 5 6	%	SW2 1 2 3 4 5 6	%
Default		Default			34		66				98
	0		5		36		68				100
	15		6		38		70				100
	20		8		40		72				100
	25		10		42		74				100
	30		12		44		76				100
	35		14		46		78				100
	40		16		48		80				100
	45		18		50		82				100
	50		20		52		84				100
	55		22		54		86				100
	60		24		56		88				100
	65		26		58		90				100
	70		28		60		92				100
	75		30		62		94				100
	80		32		64		96				100

INSTALLATION INSTRUCTIONS

The device is suitable for fitting to DIN rails in the vertical position.
For optimum operation and long life follow these instructions:

When the devices are installed side by side it may be necessary to separate them by at least 5 mm in the following cases:

- If panel temperature exceeds 45°C.
- Use of high power supply value (> 27 Vdc).
- Use of output current.

Make sure that sufficient air flow is provided for the device avoiding to place raceways or other objects which could obstruct the ventilation slits. Moreover it is suggested to avoid that devices are mounted above appliances generating heat; their ideal place should be in the lower part of the panel.

Install the device in a place without vibrations.

Moreover it is suggested to avoid routing conductors near power signal cables (motors, induction ovens, inverters etc...) and to use shielded cable for connecting signals.

ISOLATION STRUCTURE

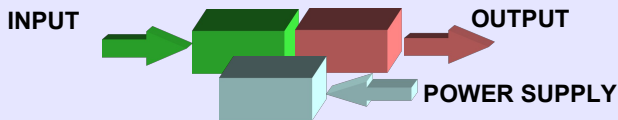

CONNECTIONS

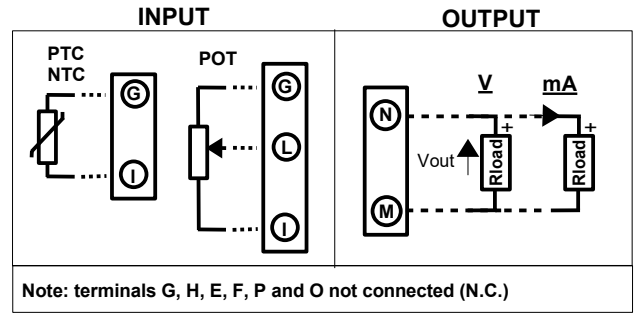

POWER SUPPLY(*)

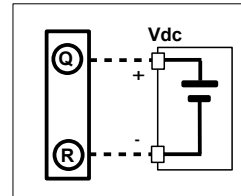

(*) Note: for UL installation the device must be powered using a power supply unit classified NEC class 2 or SELV

LIGHT SIGNALLING

LED	COLOUR	STATE	DESCRIPTION
PWR	GREEN	ON	Device powered
		OFF	Device not powered
		BLINKING	Wrong dip-switches setting

DIMENSIONS (mm)

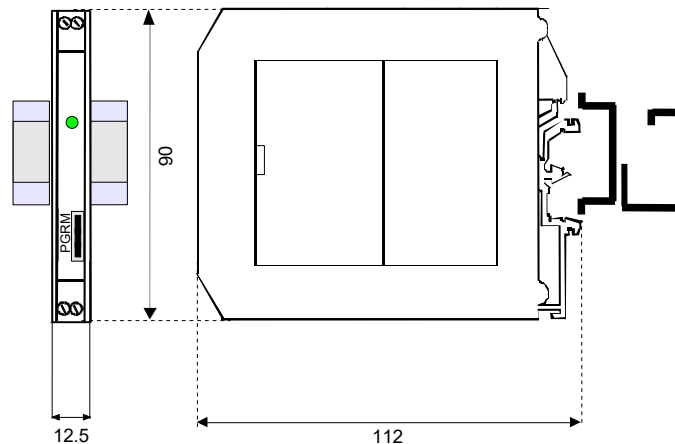

HOW TO ORDER

The device is provided as requested on the Customer's order.
Refer to the section "Programming" to determine the input and output ranges.
In case of the configuration is not specified, the parameters must be set by the user.

ORDER CODE EXAMPLE:

DAT 4531C / KTY84-130 / 0 ÷ 200 °C / 4 ÷ 20 mA

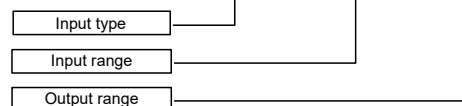

The symbol reported on the product indicates that the product itself must not be considered as a domestic waste. It must be brought to the authorized recycle plant for the recycling of electrical and electronic waste.
For more information contact the proper office in the user's city, the service for the waste treatment or the supplier from which the product has been purchased.